



湖南商务职业技术学院
Hunan Vocational College of Commerce



三年制高职 专业人才培养方案

4 . 2 . 0

0 . 0 .

0 . 0 . .

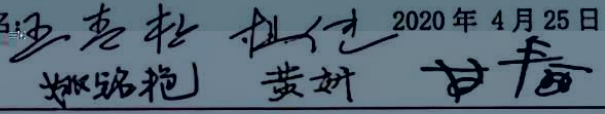
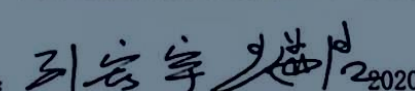
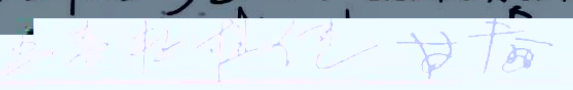
2020 级专业人才培养方案制订与审核表

专业名称	统计与会计核算
专业代码	630402
专业建设	<p style="text-align: center;">人才培养目标定位准确，课程体系设置合理，实施保障切实可行，符合现代企业人才培养需求。</p>
委员会	<p style="text-align: center;">人才培养目标定位准确，课程体系设置合理，实施保障切实可行，符合现代企业人才培养需求。</p> <p>签名:  2020年4月25日</p> <p style="text-align: center;"></p>
人才培养方案 论证会	<p style="text-align: center;">人才培养方案符合现代企业人才培养需求。</p> <p>签名:  2020年5月16日</p> <p style="text-align: center;"></p>
学术委员会	<p style="text-align: center;">人才培养目标准确，课程体系和教学进程合理，实施保障较完善，同意实施。</p> <p>签名:  2020年7月1日</p> <p style="text-align: center;"></p>



0. 0.

高中阶段教育毕业生或具备同等学力者。

八

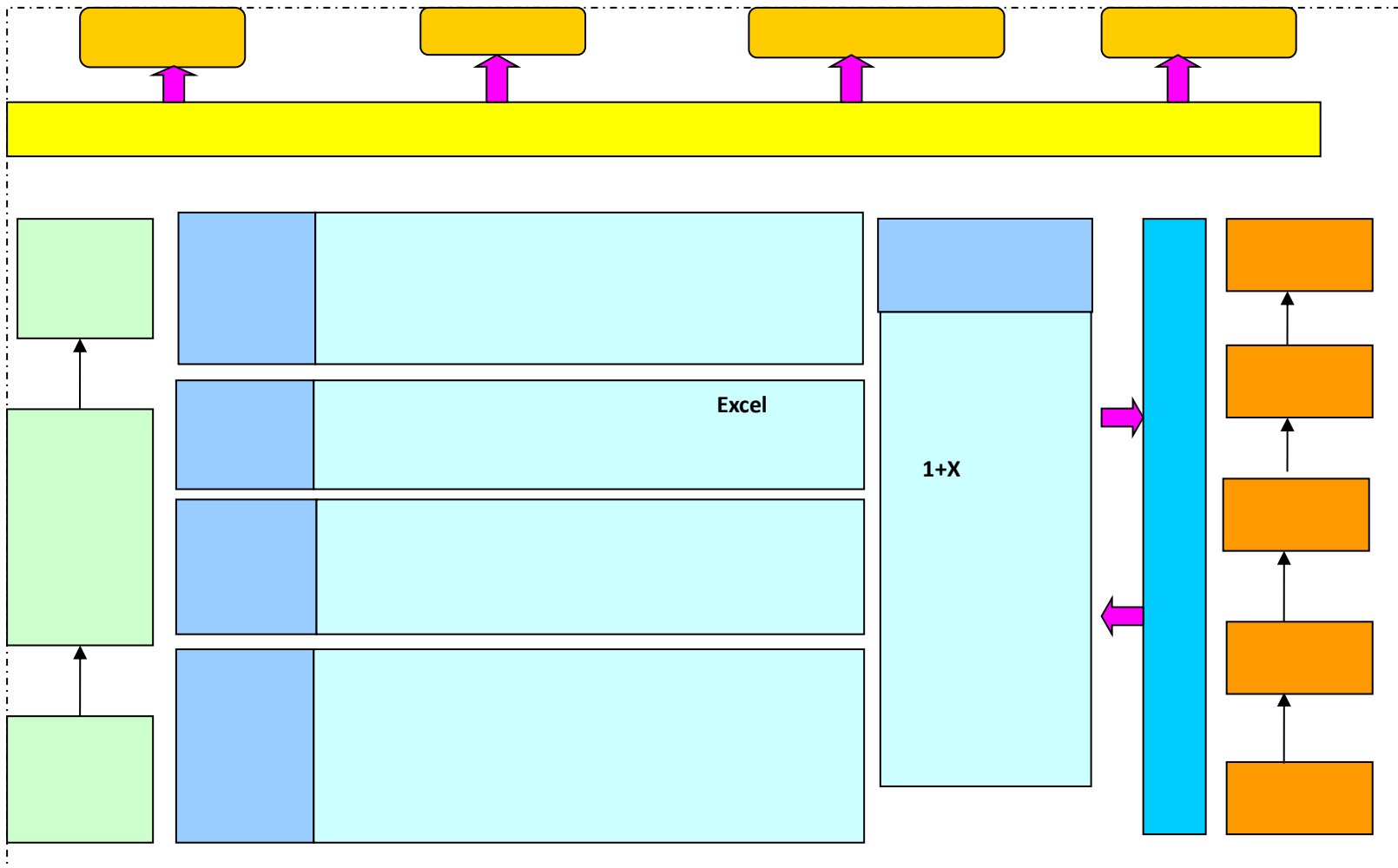

--	--	--	--	--

八

	1							
	2							
	3							
	4							
	5							
	6							
	7							
	8							
	9							
	10							
	11							
	12							
	13							
	14							
	15							
	16							
	17							
	18							
	19							
	20							
	21							
	22							
	23							
	24							
	25							
	26							
	27							
		17	18	18	19	8	0	80
		2	0	0	0	0	0	2
		1	0	1	0	6	0	8
		0	0	0	0	9	15	24
		1	1	1	1	1	1	6
		21	19	20	20	24	16	120
		5	7	6	7	0		25
		26	26	26	27	24	16	145

							1	2	3	4	5	6	
							17	18	18	19	8	0	
1	0601025	A	3.0	48	48			3					2
2	0601024	A	3.0	48	48		4*12						1
3	0601046	C	1.0	16		16	4*4						1
4	0601028	A	1.0	40	40		2*4	2*4	2*4	2*4	2*4		5
5	0801001	C	2.0	112		112	2						
6	0801215	A	2.0	36	36					2			4
7	0603001	B	2.0	32	4	28	2*16						1
8	0603002	B	2.0	32	4	28		2*16					2
9	0603003	B	2.0	32	4	28			2*16				3
10	0603004	B	1.0	16	4	12				1*16			4
11	0601039	A	2.0	32	32		2						1
12	0601070	A	1.0	16	16		2*8						1
13	0601071	A	1.0	16	16					2*8			4
14	0801080	A	2.0	32	32				2*8				3
15	0801216	B	1.0	16	16		2*8						1
16	0801217	C	1.0	28		28							5
			27.0	552	300	252	12	5	4	5	0		
17	0601072	A	1.0	16	16		1						1
18	0601069	A	1.0	16	16		1						1
19	0201241	A	2.0	32	32			2					2
20	0201232	A	1.0	16	16			1					2
21	0201039	A	3.0	48	48			3					2
22	0201039	A	3.0	48	48			3					2
23	0203001	B	2.0	32	24	8	2						1
24	0203002	B	2.0	32	24	8		2					2
25	0602013	A	3.0	48	48		3						

12	2	5	0	4	0	5	0	0	0	0	0	300	252	552
9	0	5	0	0	0	0	0	0	0	0	0	188	44	232



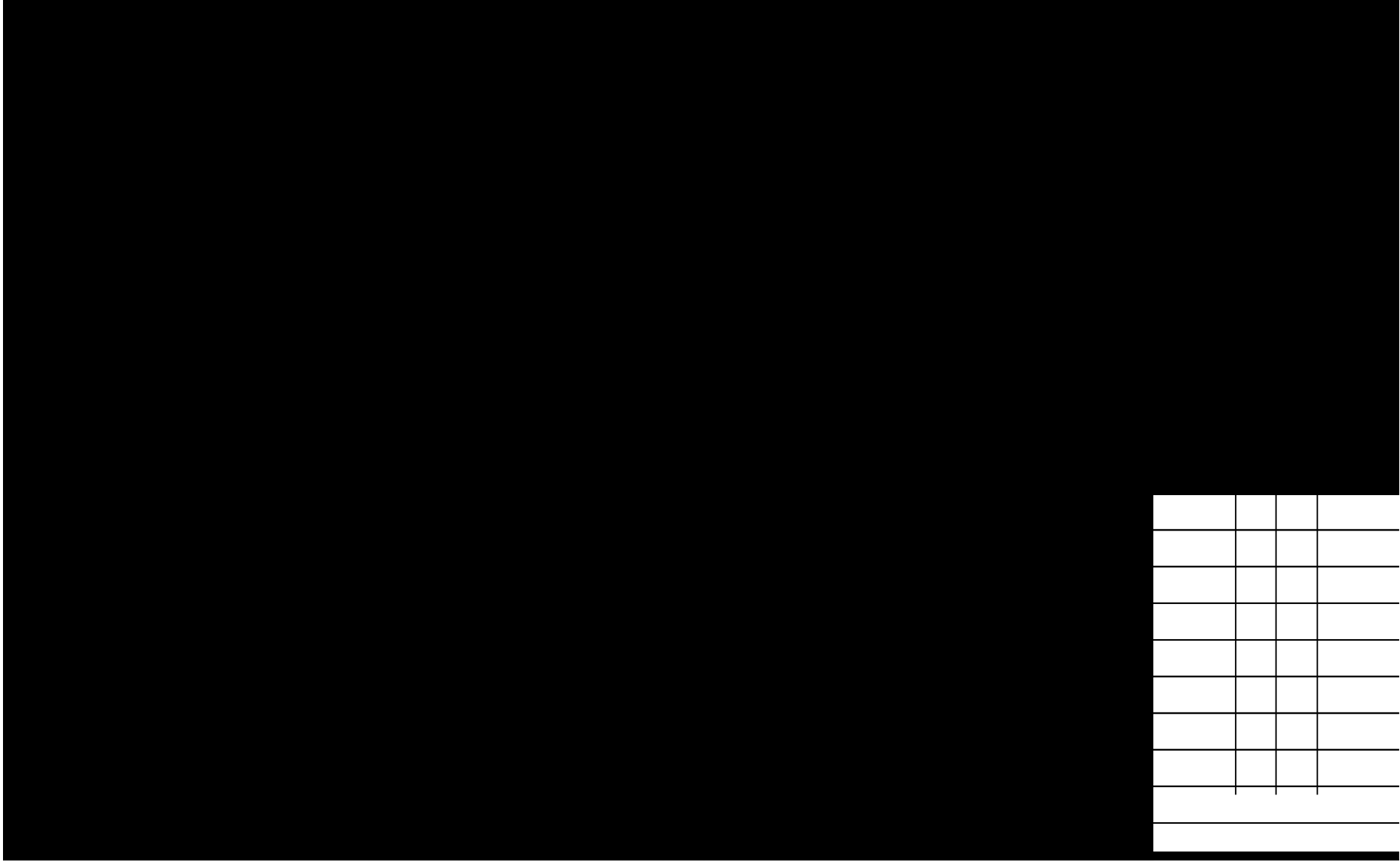

表六 课程教学进程安排表

学期	序号	课程名称	总学时	1	2	3	4	5	6	7	8	9	10	11	12	13	14	15	16	17	18	19	20	21	备注	
第五学期	1	形势与政策（五）	8 hours															⊙								
	2	“1+X”智能财税实训	28	28														⊙								
	3	统计与会计核算综合实训	140		28	28	28	28	28										⊙							
	4	模拟企业经营	48							6	6	6	6	6	6	6	6	6	⊙							
	5	统计预测与决策	40							6	6	6	6	6	6	4			⊙							
	6	电子商务/企业管理/财经应用与沟通技巧实战/市场营销	32								4	4	4	4	4	4	4	4	⊙							4选1
	7	应用统计模拟分析/企业财务分析/信息管理系统	32								4	4	4	4	4	4	4	4	⊙							3选1
	8	毕业教育																	⊙							
	9	毕业设计	14																⊙14							
	10	劳动实践	28																⊙							
	11	毕业实习	252																⊙	第16-24周						
	小计	614	28	28	28	28	28	28	28	20	20	20	20	20	20	18	14		第16-24周							
第六学期	1	毕业实习	420	第1-15周														⊙								
	2	毕业设计	14																⊙14							
		小计	434	第1-15周																						

备注：①各专业基本素养课程（含必修、限选）开课学期不同，请教研室根据《关于制订2020级专业人才培养方案实施计划的原则意见》（湘商职院发〔2019〕67号）参照本表调整、设置。

②各专业基本素养限选课程，请教研室根据专业需要及附表2的选修规定进行选择。

1

2

3